

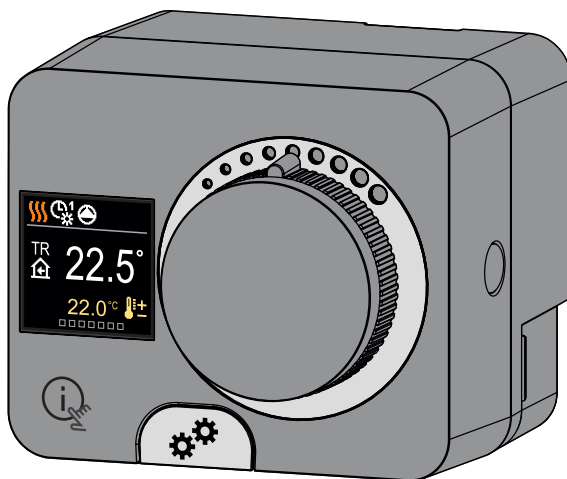

Compact weather compensated controller

AHD20



Introduction	3
--------------------	---

INSTRUCTIONS FOR USE

Appearance of the controller.....	4
Initial controller setup.....	5
Basic screens.....	7
Help	12
Entering and navigating through the menu.....	12
Menu structure and description.....	13
Requested temperatures.....	14
User functions	16
Operation mode.....	18
Time programs.....	21
Information.....	23
Display.....	26
Statistics.....	29

INSTRUCTIONS FOR SERVICE SETTINGS

User P parameters.....	31
Service S parameters	37
Function F parameters	45
Devices.....	47
Factory settings	49
Basic operation descriptions.....	50
Operation modes with sensor failure.....	54

INSTALLATION INSTRUCTIONS

Clutch and manual valve displacement	55
Controller installation.....	56
Controller electrical connections	58
Technical data.....	62
Removing old electrical and electronic equipment	63
Hydraulic schemes	64
Dimensions	65

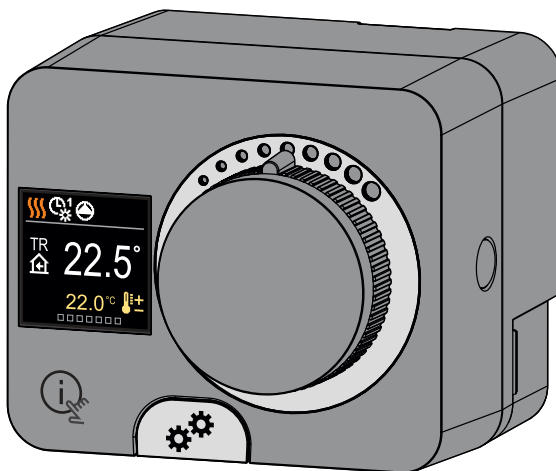

INTRODUCTION

The AHD20 is a compact, weather-compensated heating controller built into the actuator housing. It allows direct mounting on more than 20 mixing valves from various manufacturers. The controller can also be used in systems without an outdoor sensor, but then the use of a room unit is mandatory.

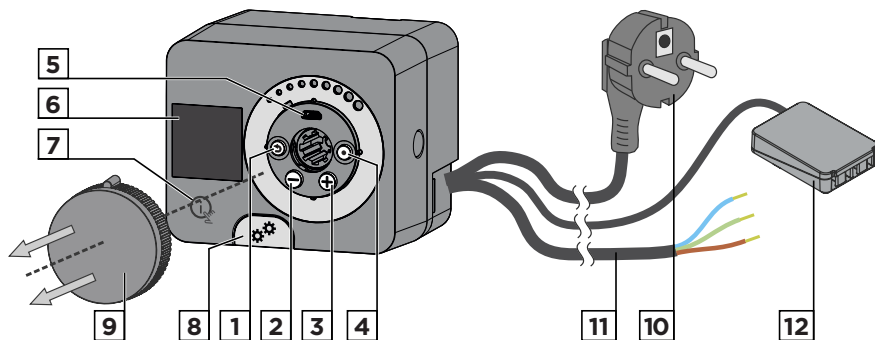

APPEARANCE OF THE CONTROLLER



1. Button . Return back.
2. Button . Move to the left, decreasing.
3. Button . Move to the right, increasing.
4. Button . Menu entry, confirmation of selection.
5. USB port for software updates and connection to a personal computer.
6. Graphic display.
7. Button . Help.
8. Manual operation clutch.
9. Manual movement button.
10. Pre-wired power cord with plug.
11. Pre-wired cable for circulation pump.
12. Pre-wired connection box for sensors and communication.

The controller is equipped with an innovative "Easy start" function, which allows the initial setting of the controller in just four steps.

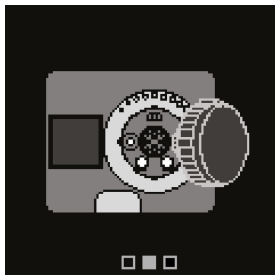

Upon the first connection of the controller to the power supply network, the first step of the controller setup is displayed after the program version and logo.

The manual movement button must be removed for the setup. The Easy start function is activated by pressing the buttons  and  and holding them both down together for 5 seconds.



STEP 1 - LANGUAGE SETUP



Use the buttons  and  to select the requested language.

Confirm the selected language by pressing .

If you've mistakenly selected the wrong language, you can return to the language selection with the  button.

i Later, you can change the language in the "Display" menu.

STEP 2 - HYDRAULIC SCHEME SETUP

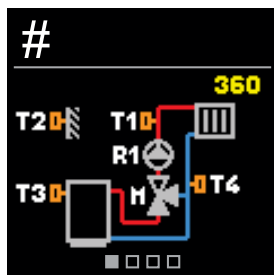

You can select the hydraulic scheme for the controller operation. Use the buttons \ominus and \oplus to navigate between schemes.

Confirm the selected scheme with the \odot button.

If you have mistakenly selected the wrong scheme, you can return to the diagram selection with the \odot button.



Later, you can change the selected hydraulic scheme with the service parameter S1.1.

STEP 3 - SETUP OF HEATING CURVE STEEPNESS



You can set the heating curve steepness. The steepness can be set with the buttons \ominus and \oplus .

Confirm the set steepness with the button \odot .

If you have accidentally set the wrong steepness, return to re-selecting the steepness with the button \odot .



Later, you can change the steepness of the heating curve with the user parameter P2.1.

STEP 4 - SELECTING THE OPENING DIRECTION OF THE MIXING VALVE

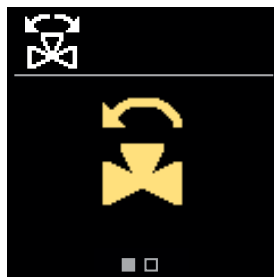

You can select the opening direction of the mixing valve. Use the buttons \ominus and \oplus to navigate between directions.

Confirm the selected direction with the \odot button.

If you have mistakenly selected the wrong direction, you can return to the direction selection with the \odot button.



Later, you can change the opening direction of the mixing valve with the service parameter S1.4.

All important data on the operation of the controller can be seen in the eight basic screens. Use the buttons ⊖ and ⊕ to navigate between the basic screens.





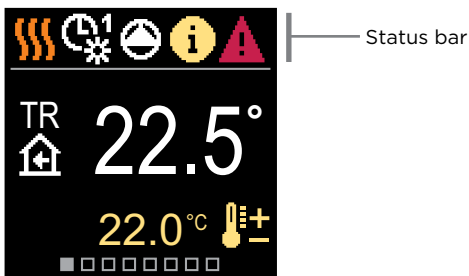







STATUS BAR

Operation mode, notifications and alerts appear in the top third of the screen.



Symbol	Description
	Room heating.
	Room cooling.
	Operation according to program timer 1 - day temperature. *
	Operation according to program timer 1 - night temperature. *
	Requested day temperature operation mode.
	Requested night temperature operation mode.
	Switch off.
	Manual operation mode.
	Circulation pump is working.

* The number indicates the selected program timer

Symbol	Description
	Turn the valve to the left.
	Turn the valve to the right.
	Manual intervention - the clutch is activated.
	PARTY operation mode.
	ECO operation mode.
	Holiday operation mode.
	Automatic heating switch off.
	Floor drying.
	Operation with constant stand-pipe temperature.
	Boost heating.
	AUX function at input T4.
	<p>Message</p> <p>In the event that the maximum temperature is exceeded or the safety function is activated, the controller notifies you with a yellow symbol on the display. When the maximum temperature is no longer exceeded or when a protection function has switched off, a gray symbol will turn on to note the recent event. The list of alerts can be viewed in the "Information" menu.</p>
	<p>Warning</p> <p>In the event of a sensor or communication connection failure, the controller informs you of the error with a red symbol on the display. If the error is corrected or is no longer present, a gray symbol indicates a recent event. The list of errors can be viewed in the "Information" menu.</p>

TEMPERATURES



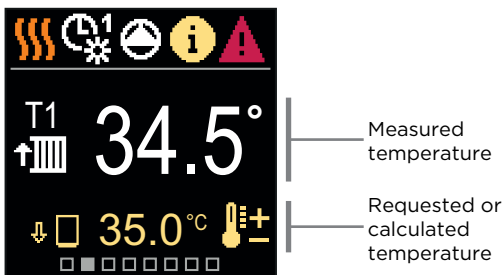

The number of temperatures displayed on the screen depends on the selected hydraulic scheme and controller settings.



Measured temperature

Requested or calculated temperature



Symbol	Description
	Calculated or requested temperature.
	Room temperature.
	Stand-pipe temperature.
	Outdoor temperature.
	Return-pipe temperature.
	Source temperature.
T1, T2, T3, T4	Temperature measured by sensors T1, T2, T3 and T4.
TR	Temperature measured by a room sensor or room unit.
TA	Outdoor temperature, obtained through the bus connection.
TQ	Heat source temperature, obtained through the bus connection.
Error	Temperature sensor error.
- - -	Temperature sensor not connected.
	Limitation of heating circuit temperature due to the unsurpassed heat source temperature.

Symbol	Description
	Limitation of the heating circuit temperature due to exceeding the maximum difference between the stand-pipe and return-pipe or exceeding the maximum power of the heating circuit.
	Limitation of heating circuit temperature due to the ED regulation.
	Heating circuit is switched off due to priority of d. h. w. warming.
	Rise of heating circuit temperature due to the exceeded protection temperature of the heat source.

PROTECTIVE FUNCTIONS

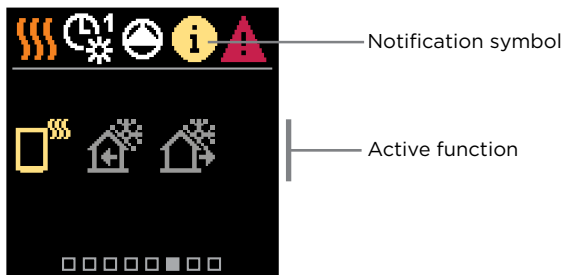
The screen shows the selected hydraulic scheme with the display of measured temperatures. When the protection function is active, the corresponding symbol turns yellow. The notification symbol in the status bar also turns yellow.



Symbol	Description
	Heat source overheating protection.
	Frost protection due to low room temperature.
	Frost protection due to low outdoor temperature.

HYDRAULIC SCHEME

The screen shows the selected hydraulic scheme with the display of measured temperatures.

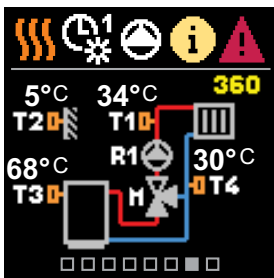

Hydraulic scheme with screen showing the measured temperatures

TIME AND DATE

The screen shows the day of the week, the current time and date.

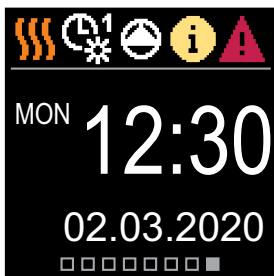





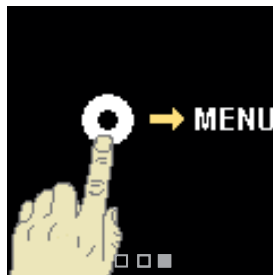
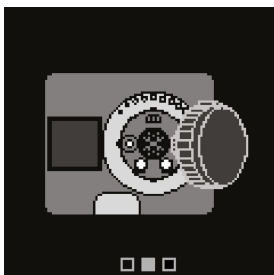

Time and date

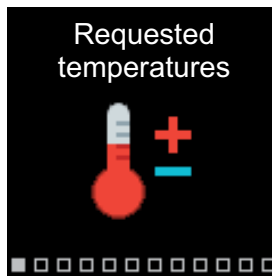
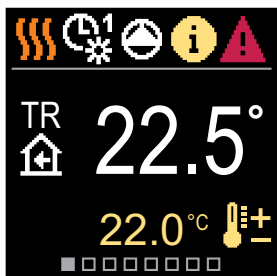
By pressing the  button we can start the display animation, which leads us to the additional settings menu.



ENTERING AND NAVIGATING THROUGH THE MENU



Press the  button to enter the menu.
 Navigate through the menu with the  and  buttons and use the  button to confirm your selection. Press the  button to return to the previous screen.

MENU STRUCTURE AND DESCRIPTION

The menu consists of twelve main groups:

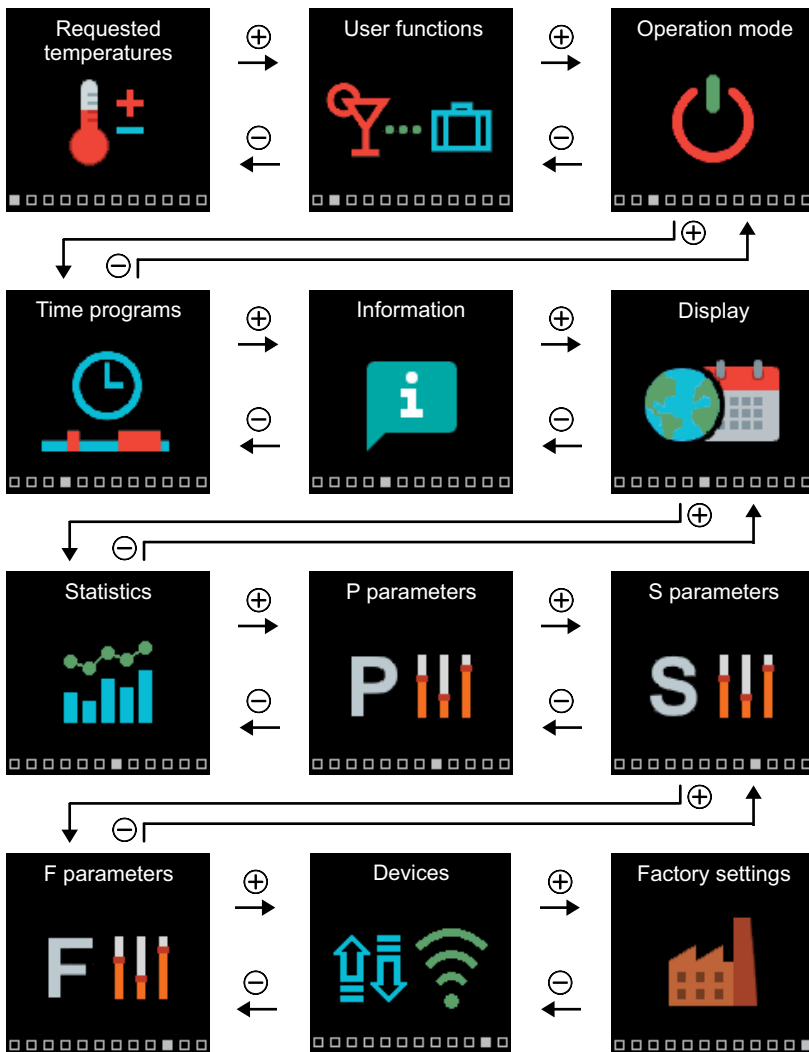

REQUESTED TEMPERATURES

In the menu, you can change the setting of the requested temperatures.

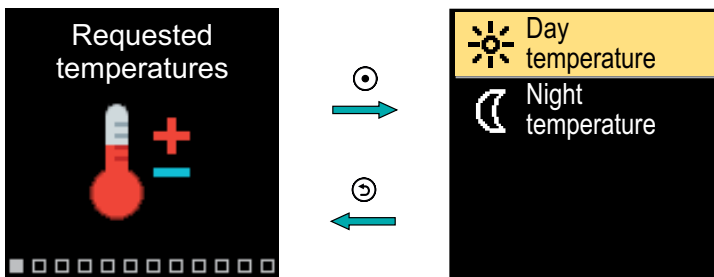

Navigate through the menu with the \ominus and \oplus buttons and use the \odot button to confirm your selection. A new screen with temperatures will open.

REQUESTED DAY TEMPERATURE

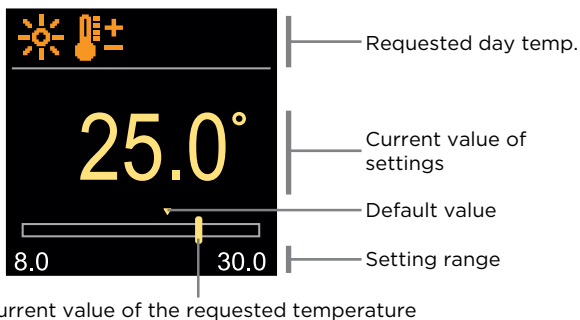

Use the \ominus and \oplus buttons to select the requested temperature and confirm it with the \odot button. Exit the setting with the \ominus button.

REQUESTED NIGHT TEMPERATURE

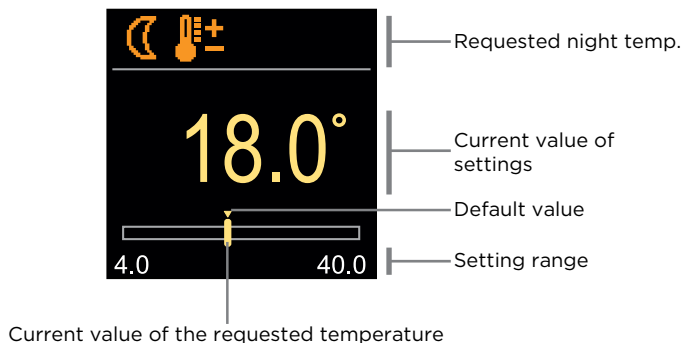

Use the \ominus and \oplus buttons to select the requested temperature and confirm it with the \odot button. Exit the setting with the \odot button.

i When the controller is in Heating mode, the symbol of the requested temperature is colored orange, and when the controller is in Cooling mode, the symbol is colored blue.

User functions enable additional comfort and benefits of using the controller.

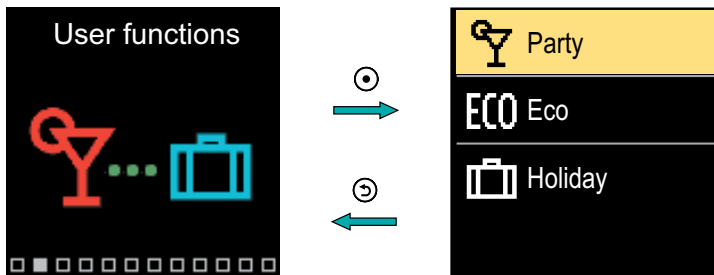

Navigate through the menu with the \ominus and \oplus buttons and use the \odot button to confirm your selection. The screen for turning on and setting the user function opens.

PARTY USER FUNCTION

The PARTY function activates the operation according to the requested comfort temperature until the set end time.

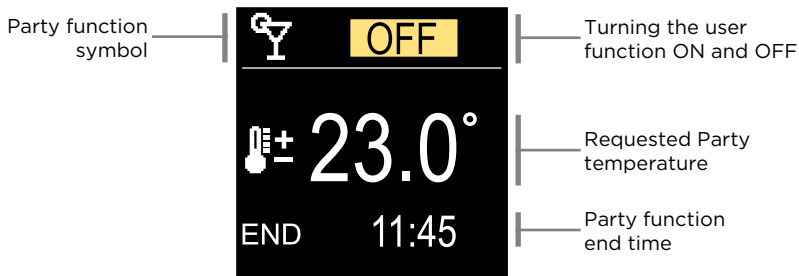

With the buttons \ominus and \oplus you can change the setting value and with the button \odot you can move on to the next setting.

ECO USER FUNCTION

The ECO function activates the operation according to the requested saving temperature until the set end time.

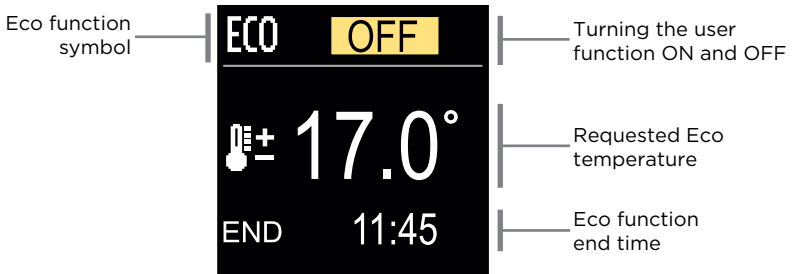

With the buttons \ominus and \oplus you can change the setting value and with the button \odot you can move on to the next setting.

HOLIDAY USER FUNCTION

The Holiday function activates the operation according to the requested saving temperature until the set end time.

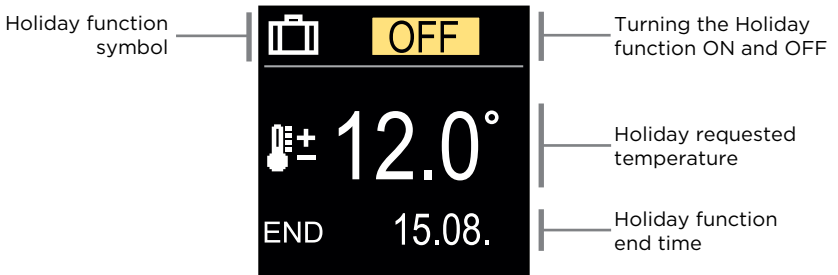

With the buttons \ominus and \oplus you can change the setting value and with the button \odot you can move on to the next setting.

In the menu, you can select the requested operation mode and other operation options.

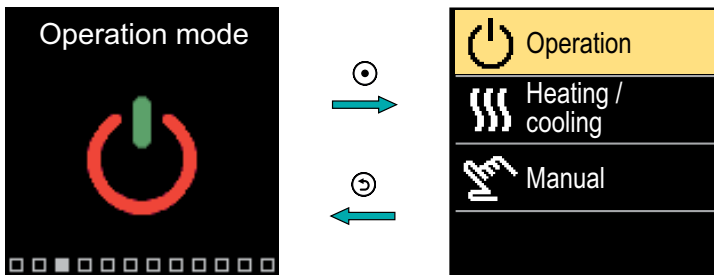



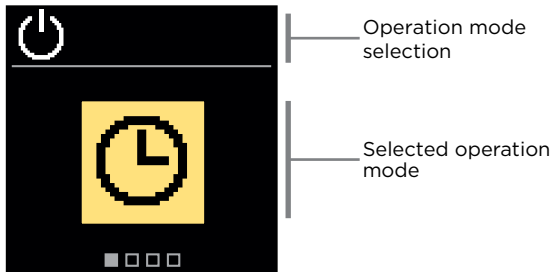

Navigate through the menu with the ⊖ and ⊕ buttons and use the ⊙ button to confirm your selection.

OPERATION SELECTION

In the menu, you can select the requested operation mode.



Use the buttons ⊖ and ⊕ to select the requested operation.
Exit the setting by pressing ⊙ or ⊖.

Symbol	Description
	Operation according to the selected time program with day and night temperature which is set on the controller.
	Requested day temperature operation mode.
	Requested night temperature operation mode.
	Switch-off. Frost protection remains active, if operation mode heating is selected. The overheating protection remains active, if operation mode cooling is selected.

SELECTING HEATING OR COOLING OPERATION

In the menu, select the requested heating or cooling operation mode.

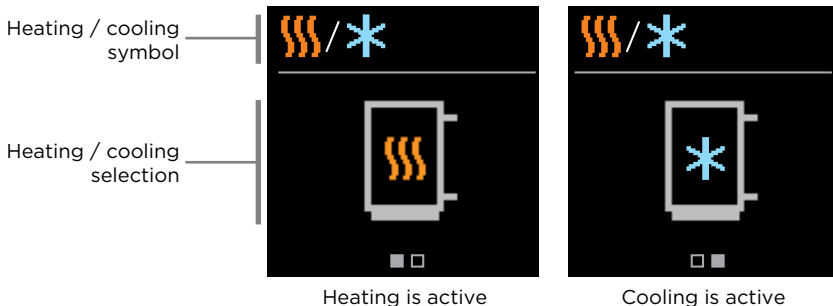

You can select heating or cooling with the buttons \ominus and \oplus .
Exit the setting by pressing \odot or \odot .

MANUAL OPERATION MODE

This operation mode is used when testing the heating system or in the event of a malfunction. The control output can be manually switched on, switched off or automatic operation can be selected.

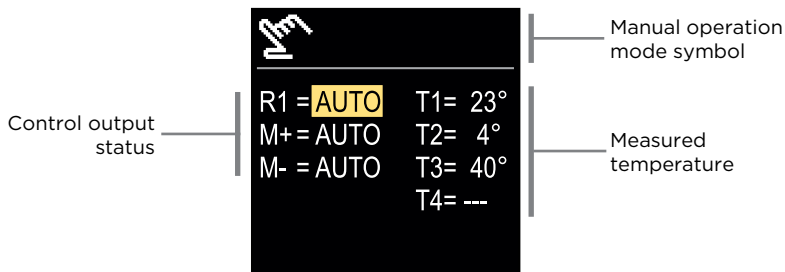

With the buttons \ominus and \oplus you can move between the individual outputs R1, M + or M-, and with the button \odot you can select the AUTO, OFF or ON status. Exit the setting by pressing \odot .

Weekly time programs enable automatic switchover between day and night temperature. There are two time programs available. A check mark next to the time program tells which time program is selected for operation.

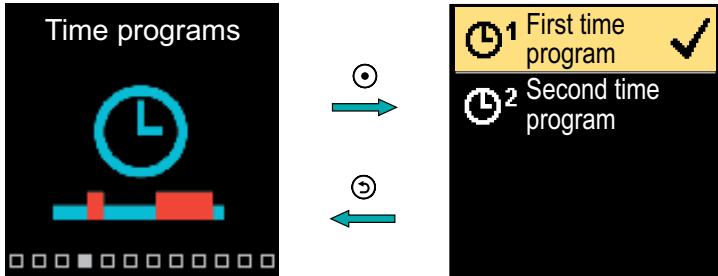

Navigate through the menu with the ⊖ and ⊕ buttons. With the button ⊕ you can select the time program for operation and with the button ⊖ you can enter the setting of the selected time program.

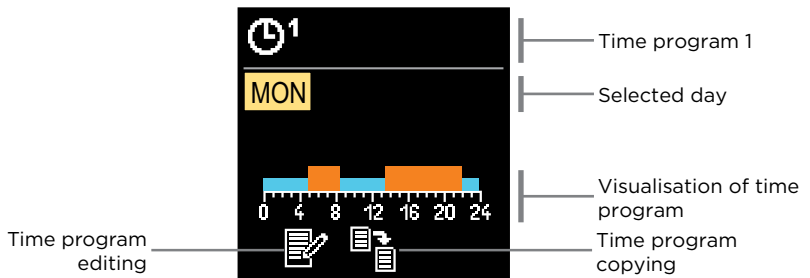

With the buttons ⊖ and ⊕ you can select the day for which you want to edit or copy the time program and confirm it with the button ⊕. Now, with the buttons ⊖ and ⊕ select the icon to edit or copy the time program and confirm it with the button ⊕.

Default settings of time programs:

⌚ ¹	Mon - Fri	05:00 - 07:30 and 13:30 - 22:00
	Sat - Sun	07:00 - 22:00
⌚ ²	Mon - Fri	06:00 - 22:00
	Sat - Sun	07:00 - 23:00

TIME PROGRAM EDITING

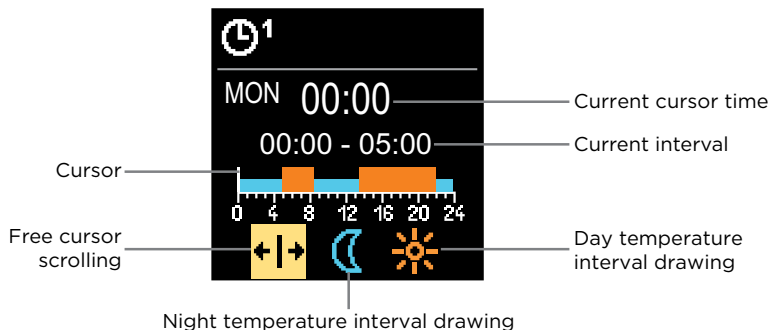

With the button select the requested icon to scroll or draw the interval, using the buttons and you can draw the requested course of the time interval. Exit the time program editing by pressing the button .

TIME PROGRAM COPYING

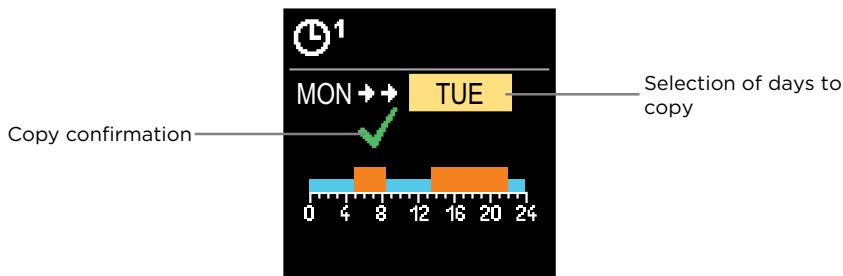

With the buttons and you can select the day for which you want to edit or copy the time program of the displayed day. Confirm the time program copying by pressing the button . Exit the time program copying by pressing the button .

The menu is used to display information about the controller, notifications and errors.

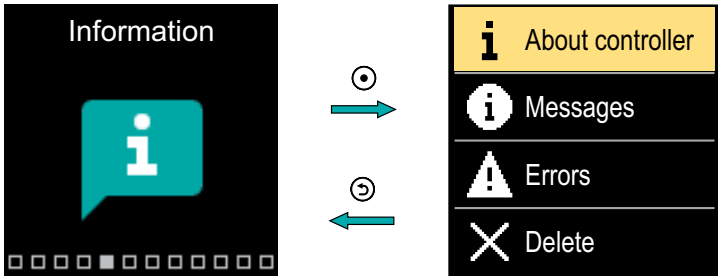

Navigate through the menu with the ⊖ and ⊕ buttons and use the ⊙ button to confirm your selection.

ABOUT THE CONTROLLER

The basic information about the controller is displayed on the screen.

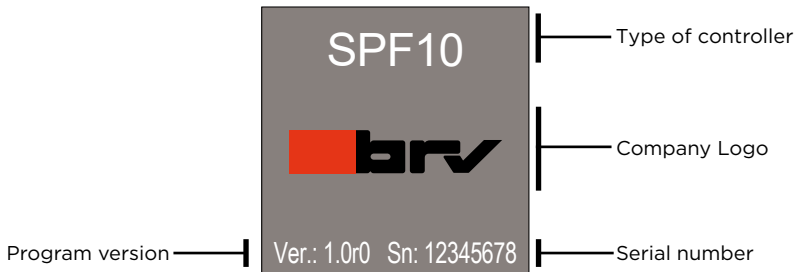

Exit the screen with the ⊙ button.

MESSAGES

A list of messages is displayed on the screen with the time and date of the individual message.

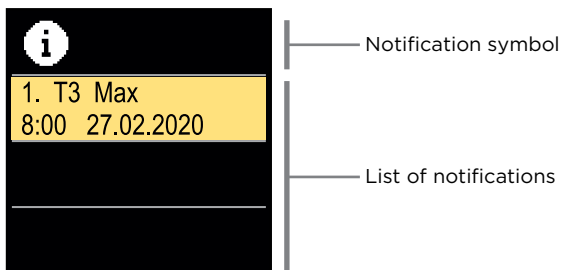

Navigate through the notifications with the \ominus and \oplus buttons. Exit the screen with the button \odot .

ERRORS

A list of errors is displayed on the screen with the time and date of the individual errors.

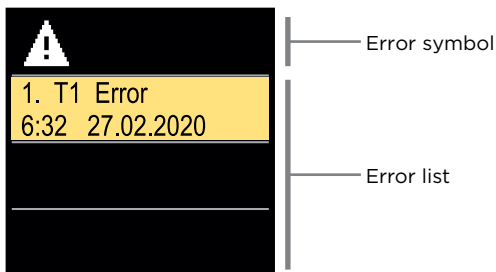

Navigate through the error list with the \ominus and \oplus buttons. Exit the screen with the button \odot .

DELETING THE MESSAGES AND ERRORS

The list of messages and errors is deleted. The list of warnings for errors of all unconnected sensors is also deleted.

i *Sensor errors that are essential for the controller operation cannot be deleted.*

The deletion must be confirmed by entering the 4-digit unlock code.

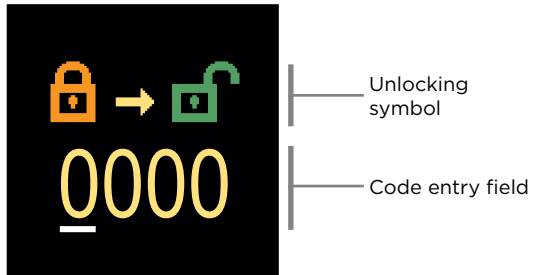

With the buttons \ominus and \oplus you can change the value and with the button \odot you can move on to the next position and confirm the unlocking. Exit the screen with the button \odot .

i *The factory set code is "0001".*

The menu is for basic on-screen display settings.

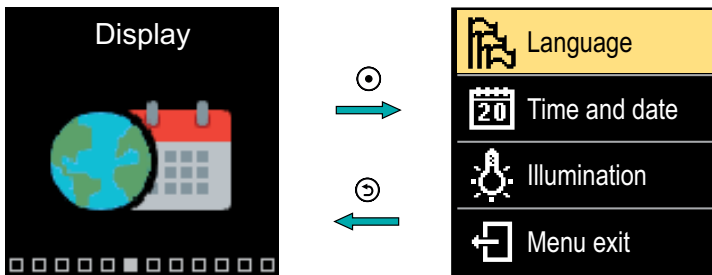

Navigate through the menu with the \ominus and \oplus buttons and use the \odot button to confirm your selection.

LANGUAGE SELECTION

A list of available languages appears on the screen.

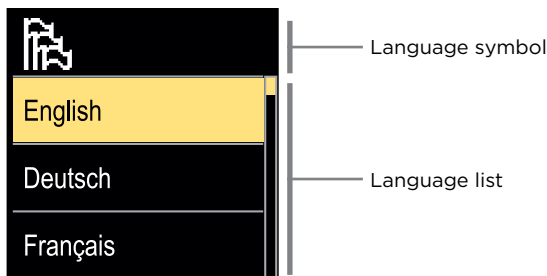

Use the \ominus and \oplus buttons to select the language and confirm it with the \odot button. Exit the setting by pressing $\omin�$.

TIME AND DATE SETTINGS

You can set the exact time and date.



With the buttons \ominus and \oplus you can change the value and with the button \odot you can move on to the next data. Exit the screen with the button \odot .

ADJUSTING THE SCREEN BRIGHTNESS

You can adjust the screen brightness.

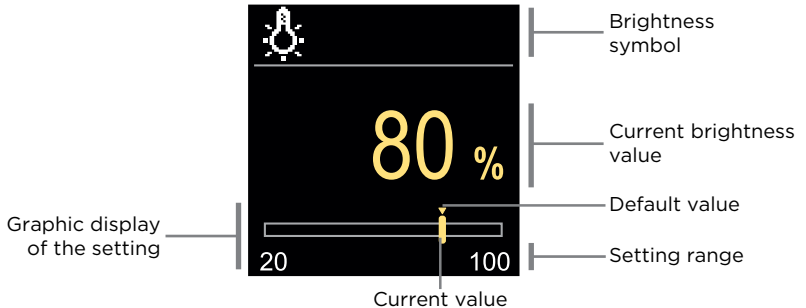

Use the \ominus and \oplus buttons to adjust the brightness and confirm it with the \odot button. Exit the setting with the \odot button.

SETTING THE MENU EXIT TIME

You can set the time to automatically exit the menu.

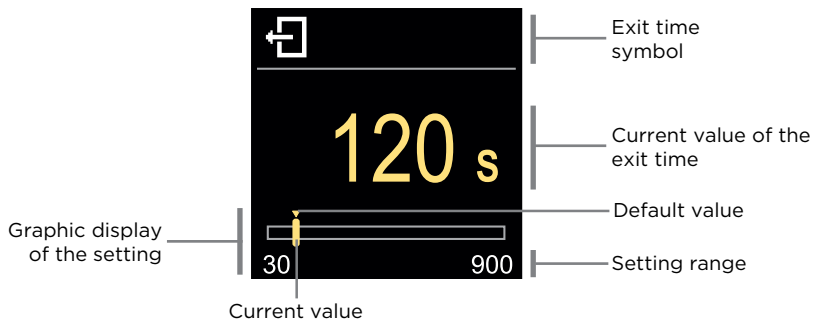

With the \ominus and \oplus buttons you can set the automatic exit time and confirm it with the \odot button. Exit the setting with the \odot button.

The menu is intended to display detailed information on the operation of the controller.

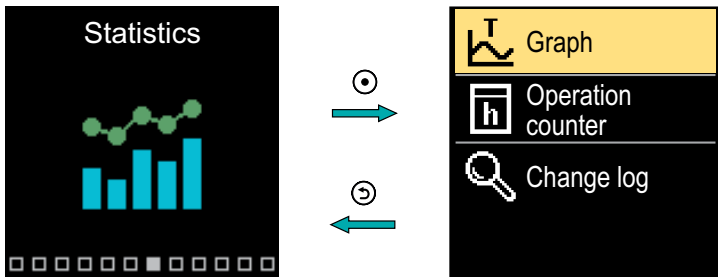

Navigate through the menu with the ⊖ and ⊕ buttons and use the ⊙ button to confirm your selection.

TEMPERATURE GRAPH

A 24-hour temperature graph for all four temperature sensors is displayed on the screen.

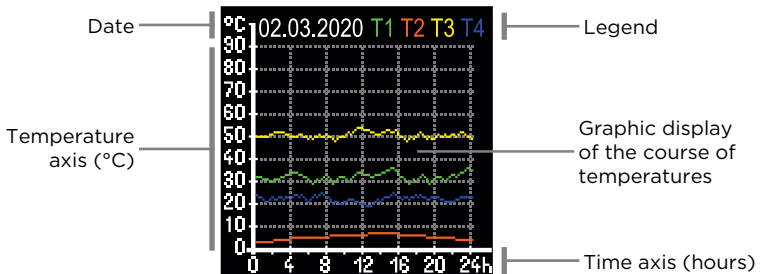



With the buttons ⊖ and ⊕ you can browse the temperature graphs for the last 7 days of operation. Exit the setting by pressing ⊙.

OPERATION COUNTER

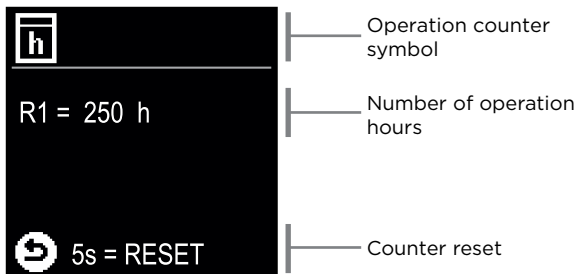
The display shows the number of operation hours of the R1 circulation pump output.



By pressing the button  for 5 seconds, you can reset the counter to 0.
Exit the setting by pressing .

CHANGE LOG

A list of changed P, S and F parameters of the controller is displayed on the screen.

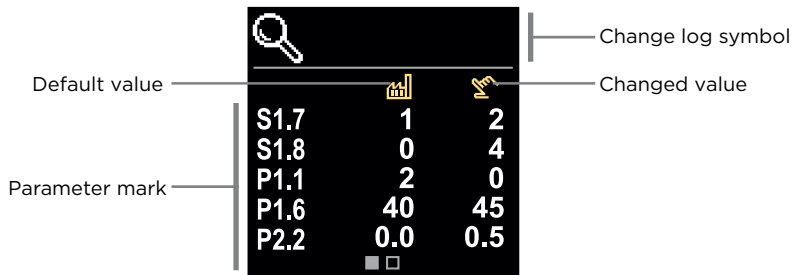

Navigate through the change list with the  and  buttons.
Exit the screen with the button .

The menu is used to display and set user parameters. The parameters are classified into groups **P1** - basic settings, **P2** - settings for the heating circuit and **P3** - settings for the power source.

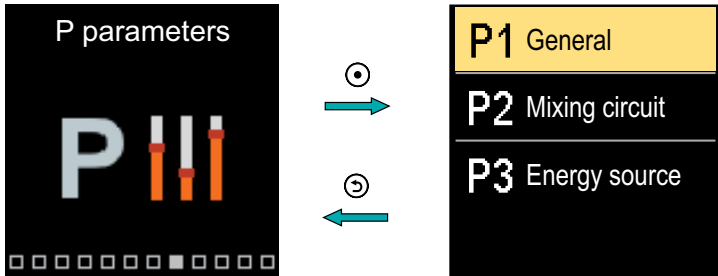

Navigate through the menu with the ⊖ and ⊕ buttons. When you use the ⊕ button to select the requested parameter group, a display will open describing the first parameter in the group.

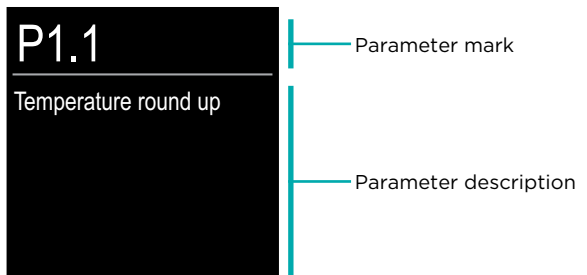

With the ⊖ and ⊕ buttons navigate through the parameters in the selected group. The parameter you want to change is selected by pressing the ⊕ button. The parameter setting screen, which can take the form of a menu or a slider, opens.

Menu format setting:

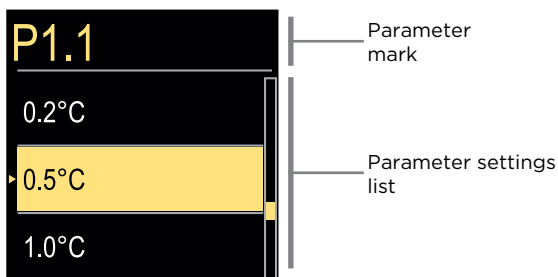

Use the \ominus and \oplus buttons to select the requested setting and confirm it with the \odot button. Exit the setting with the \odot button.

Slider format setting:

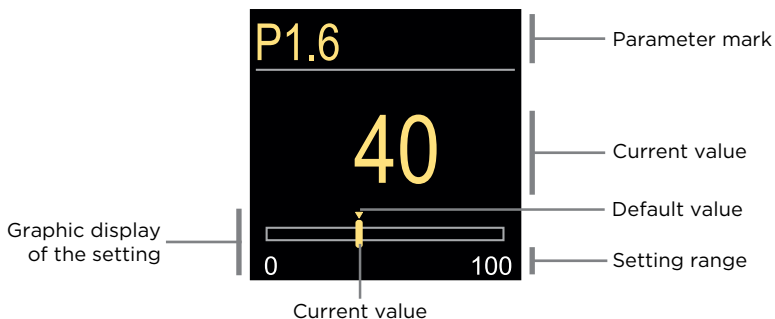

Use the \ominus and \oplus buttons to set the requested value and confirm it with the \odot button. Exit the setting with the \odot button.

P1 - BASIC SETTINGS

Parameter	Parameter name	Parameter description	Setting range	Default value
P1.1	Temperature round up	You set the accuracy of displayed temperatures.	- 0.1 °C - 0.2 °C - 0.5 °C - 1 °C	0.5 °C
P1.2	Automatic shift of clock to summer/ winter time	With the help of a calendar, the controller carries out the automatic changeover between summer and winter time.	- No - Yes	Yes
P1.4	Tones	By setting this field you define sound signals of the controller.	- Off - Keypad - Errors - Keypad and Errors	Keypad
P1.6	Sensitivity of "Help" key	This setting sets the sensitivity of the "Help" key.	0 ÷ 100 %	40 %
P1.7	Automatic switchover summer / winter	Automatic switch-off of heating in accordance to average one-day outdoor temperature.	- No - Yes	Yes
P1.8	Average outdoor temperature for summer / winter switchover	Setting of average one-day outdoor temperature at which the heating should switch-off.	10 ÷ 30 °C	18
P1.9	Outdoor temperature for activation of frost protection	Setting of outdoor temperature by which the frost protection will activate and run boiler at minimum temperature.	-30 ÷ 10 °C	2
P1.10	Requested room temperature by frost protection	Setting of room temperature when heating is switched off.	2 ÷ 12 °C	6

Parameter	Parameter name	Parameter description	Setting range	Default value
P1.12	Level of protection against frost	<p>With this setting, we determine the level of protection against frost that depends on the assessment of the possibilities for frost on the facility.</p> <ul style="list-style-type: none"> - No protection: Choose, when there is no possibility of frost on the facility. - Level 1: Choose, when there is a possibility of frost on the facility and room temperature sensor isn't connected. - Level 2: Choose, when there is a possibility of frost on the facility and room temperature sensor is connected. - Level 3: Choose, when the possibility of frost on the facility is considerable and parts of the heating system are particularly exposed to freezing. 	<ul style="list-style-type: none"> - No protection - Level 1 - Level 2 - Level 3 (greatest protection) 	Level 1
P1.13	Compensation of the effect of building on outdoor temperature sensor	This setting enables compensation of the effect of heat passing through the exterior walls of a heated building on the temperature of the outdoor sensor.	-5.0 ÷ 0.0 °C	-2,0

P2 - HEATING CIRCUIT SETTINGS

Parameter	Parameter name	Parameter description	Setting range	Default value
P2.1	Heat curve steepness	Heating curve steepness indicates what temperature is required for the heating bodies by a determined outdoor temperature.	0,1 ÷ 2,6	0,5 - floor 1,0 - radiators
P2.2	Parallel shift of heating curve	Parallel shift of heating curve (calculated stand pipe temperature). Use this setting to eliminate deviation between actual and set-point room temperature.	-15 ÷ 15 °C	0
P2.3	Duration of BOOST heating	Duration of boosted room temperature by changeover from night to day heating period.	0 ÷ 200 min	0
P2.4	Room temp. increase by boost heating	Setting of boost temperature by changeover from night to day heating period.	0 ÷ 8 °C	3
P2.5	The priority of D.H.W. warming	Setting if d. h. w. heating has priority to room heating.	- No - Yes	No
P2.6	Cooling curve steepness	Cooling curve steepness indicates what temperature is required for the cooling bodies by a determined outdoor temperature.	0,1 ÷ 2,6	0,5
P2.7	Parallel shift of cooling curve	Parallel shift of cooling curve (calculated stand pipe temp.). Use this setting to eliminate deviation between actual and set-point room temperature.	-15 ÷ 15 °C	0

P3 - SETTINGS FOR ENERGY SOURCE

Parameter	Parameter name	Parameter description	Setting range	Default value
P3.1	Minimum boiler temperature	Setting of minimal boiler temperature.	1 ÷ 90 °C	35

The menu is used to display and set user parameters. The parameters are classified into groups **S1** - basic settings, **S2** - settings for the heating circuit and **S3** - settings for the power source.

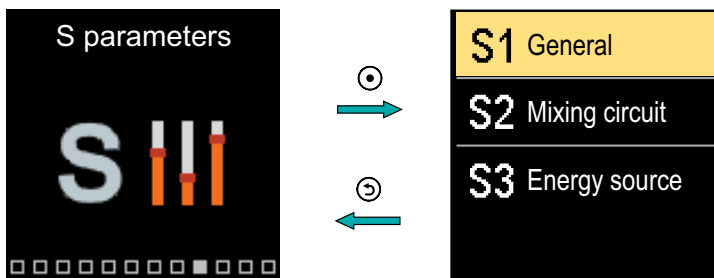

Navigate through the menu with the \ominus and \oplus buttons. When you use the \oplus button to select the requested parameter group, a display will open describing the first parameter in the group.

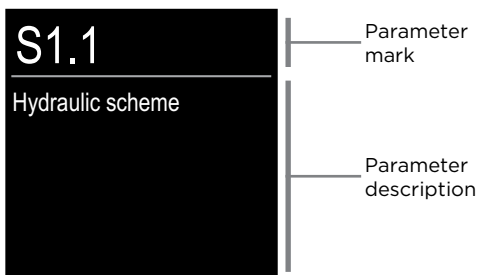

With the \ominus and \oplus buttons navigate through the parameters in the selected group. The parameter you want to change is selected by pressing the \oplus button. The parameter setting screen opens.



Only a trained professional shall perform the changing of service parameters.

SERVICE S PARAMETERS

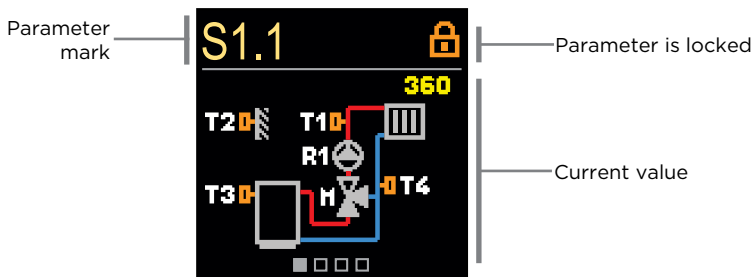

With the \ominus and \oplus buttons navigate through the parameters in the selected group. The parameter you want to change is selected by pressing the \odot button.

The S parameters are locked at the factory, so they must be unlocked by entering the 4-digit unlock code before changing.

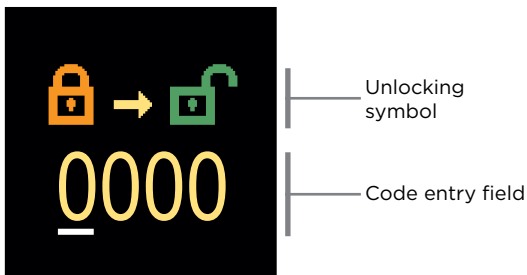

With the buttons \ominus and \oplus you change the value and with the button \odot you move on to the next position and confirm the unlocking.

i *The factory set code is "0001".*

When the parameter is unlocked, you can use the buttons \ominus and \oplus to set the requested value and press \odot confirm. Exit the setting by pressing \odot .

S1 - BASIC SETTINGS

Parameter	Parameter name	Parameter description	Setting range	Default value
S1.1	Hydraulic scheme	Selection of hydraulic scheme.	360 ÷ 360b	360
S1.2	Code for unlocking the service settings	This setting enables the change of code which is necessary to unlock the service settings. WARNING! Keep new code on a safe place. Without this code is impossible to change service settings.	0000 ÷ 9999	0001
S1.3	Actuator opening direction	Setting of actuator turning direction - valve opening.	- Left - Right	Left
S1.4	Antiblock function for mixing valve and pump	If no control output has been switched on in a specific time frame (in a week or day), it automatically turns on for 60 seconds.	- No - Yes, weekly - Yes, daily	Yes, weekly
S1.5	Cooling operation mode	Set up the cooling operation mode: - Auto: Room and outdoor temperature are considered. - Outdoor temperature: Only the outdoor temperature is considered. - Room temperature: Only the room temperature is considered. - Constant temperature: The stand-pipe calculation is constant in the daily time interval (setup of parameter S2.11).	- Auto - Outdoor temperature - Room temperature - Constant temperature"	Auto
S1.6	Selection of sensor T3 function	Set the operation mode for sensor T3.	- No sensor - Room sensor	No sensor
S1.7	Selection of sensor T4 function	Set the operation mode for sensor T4. If return pipe sensor is selected, a limitation of temperature difference between stand and return pipe needs to be set with parameter S2.13. Thus the maximum power of the heating circuit will be limited.	- No sensor - Room sensor - Return pipe sensor	No sensor

SERVICE S PARAMETERS

Parameter	Parameter name	Parameter description	Setting range	Default value
S1.8	Building type (time constant)	Selection of building type (time constant). For heavy (thick walls) and good isolated buildings select higher value. For light (thin walls, no heat accumulation) and poor isolated objects select lower value.	0 ÷ 12 h	0
S1.9	Selection of AUX (T4) input function	Set the operation mode of the controller if a short circuit is detected at the AUX (T4) input. - Day temperature: Operation according to the requested day temperature. - Cooling: Switching the controller operation mode to cooling. - Time program: Operation according to selected time program. - Boost heating: Activation of boost heating function.	- No function - Day temperature - Cooling - Time program - Boost heating	No function
S1.17	Sensor T1 calibration	Correction of measured temperature for sensor T1.	-5 ÷ 5 °C	0 °C
S1.18	Sensor T2 calibration	Correction of measured temperature for sensor T2.	-5 ÷ 5 °C	0 °C
S1.19	Sensor T3 calibration	Correction of measured temperature for sensor T3.	-5 ÷ 5 °C	0 °C
S1.20	Sensor T4 calibration	Correction of measured temperature for sensor T4.	-5 ÷ 5 °C	0 °C

S2 - HEATING CIRCUIT SETTINGS

Parameter	Parameter name	Parameter description	Setting range	Default value
S2.1	Influence of room temperature deviation	Set the value of gain of room temperature deviation. Lower value means lower influence, higher value means higher influence.	0,0 ÷ 3,0	1

SERVICE S PARAMETERS

Parameter	Parameter name	Parameter description	Setting range	Default value
S2.2	Influence of room sensors T3 and T4	Set whether the room sensor T3 or T4 influences the controller operation. - Auto: Room sensor has influence if room unit isn't connected. - Yes: Room sensor has influence. - No: Room sensor has no influence. This function has meaning only if the analog room sensor is selected with the parameter S1.6 (for T3) or S1.7 (for T4).	- Auto - Yes - No	Auto
S2.4	Pump operation mode	Setting of pump operation mode. Settings have the following meaning: - Standard: Circulation pump of mixing circuit - regular. - First program: Operation according to first time program. - Second program: Operation according to second time program. - Selected program: Operation according to selected time program.	- Standard - First program - Second program - Selected program	Standard
S2.5	Minimum stand-pipe temperature	Setting of minimum stand-pipe temperature limitation.	10 ÷ 90 °C	20
S2.6	Maximum stand-pipe temperature	Setting of maximum stand-pipe temperature limitation.	20 ÷ 150 °C	45 - floor 85 - radiators
S2.7	Backlash of mixing valve (seconds)	Setting of mixing valve running time to compensate the backlash of actuator and mixing valve assembly, which occurs by change of rotation direction.	0 ÷ 5 seconds	1 s
S2.8	Mixing valve P - constant	Setting of mixing valve position correction intensity. Smaller value means shorter movements, higher value means longer movements,	0,5 ÷ 2,0	1

SERVICE S PARAMETERS

Parameter	Parameter name	Parameter description	Setting range	Default value
S2.9	Mixing valve I - constant	Setting of mixing valve control frequency - how often mixing valve position is being controlled. Smaller value means low frequency, higher value means higher frequency.	0,4 ÷ 2,5	1
S2.10	Mixing valve D - constant	Sensitivity of mixing valve for stand-pipe temperature changes. Smaller value means low sensitivity, higher value means high sensitivity.	0,4 ÷ 2,5	1
S2.11	Minimum stand-pipe temperature for cooling	Setting of minimum stand-pipe temperature in cooling mode. CAUTION! Too low stand-pipe temperature can cause dewing of heating bodies and pipelines.	10 ÷ 20 °C	15
S2.12	Heating-off temperature shift	Shift of calculated stand-pipe temperature for heating switch-off.	-10 ÷ 10 °C	0
S2.13	Limitation of temperature difference between stand and return pipe	Setting of maximal difference between stand-pipe and return-pipe temperature. Limiting the highest power of heating system .	3 ÷ 30 °C	10
S2.14	Constant stand-pipe temperature	Selection of operation with constant stand-pipe temperature. Setting range is 10 ÷ 140 °C. CAUTION! This function deactivates weather compensated control of mixing valve.	- No - Yes	No
S2.15	Circulation pump - switch-off delay (minutes)	Setting of delayed circulation pump switch-off when there is no requirement for heating.	0 ÷ 10 minutes	3
S2.16	Influence of room temperature deviation for cooling	Set the value of gain of room temperature deviation for cooling. Lower value means lower influence, higher value means higher influence.	0,0 ÷ 3,0	1

SERVICE S PARAMETERS

Parameter	Parameter name	Parameter description	Setting range	Default value
S2.19	Initial valve movement from open position (seconds)	Setting of initial valve movement duration when moving from open position. With this setting the valve is moved to its control range and immediate controller respond at startup of system.	0 ÷ 30 seconds	20 s
S2.20	Initial valve movement from closed position (seconds)	Setting of initial valve movement duration when moving from closed position. With this setting the valve is moved to its control range and immediate controller respond at startup of system.	0 ÷ 30 seconds	20 s

S3 - SETTINGS FOR ENERGY SOURCE

Parameter	Parameter name	Parameter description	Setting range	Default value
S3.1	Maximum boiler temperature	Setting of maximal boiler temperature.	60 ÷ 160 °C	90
S3.2	Boiler temperature increase for mixing circuit	Setting of difference between boiler temperature and calculated stand-pipe temperature.	0 ÷ 25 °C	5
S3.12	Solid fuel boiler protection temperature	Setting of solid fuel boiler protection temperature. If this temperature is exceeded, controller gradually starts to increase calculated stand-pipe temperature in circuit.	70 ÷ 90 °C	77

The menu is used to display and set function parameters.
Group F1 contains the parameters for the setting of floor drying.

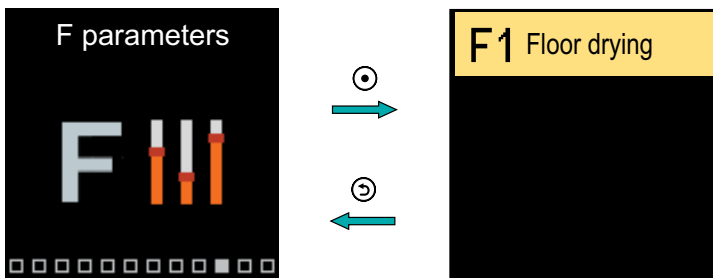

i The procedure for setting F parameters is the same as for service parameters.

F1 - FLOOR DRYING SETTINGS

Parameter	Parameter name	Setting range	Default value
F1.1	Floor drying	- No - Yes	No
F1.2	Interval 1: Start temperature (°C)	10 ÷ 60 °C	20
F1.3	Interval 1: Duration (days)	1 ÷ 15 days	10
F1.4	Interval 2: Start temperature (°C)	10 ÷ 60 °C	20
F1.5	Interval 2: Duration (days)	1 ÷ 15 days	5
F1.6	Interval 3: Start temperature (°C)	10 ÷ 60 °C	45
F1.7	Interval 3: Duration (days)	1 ÷ 15 days	5
F1.8	Interval 4: Start temperature (°C)	10 ÷ 60 °C	45
F1.9	Interval 4: Duration (days)	1 ÷ 15 days	5
F1.10	Interval 4: End temperature (°C)	10 ÷ 60 °C	20

Floor drying profile - factory setting:

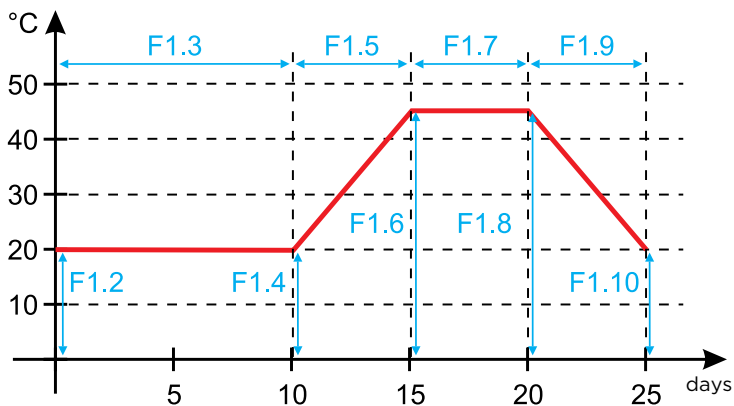

After the floor has dried, the function switches off automatically.

The menu is used to display and set the devices connected to the controller. Devices are divided according to the type of communication they use.

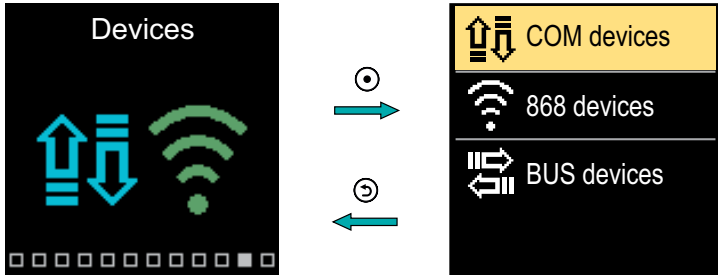

COM DEVICES

A list of devices connected to the wired COM connection appears on the screen.

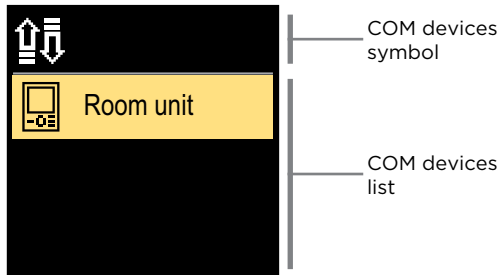

Navigate through the list with the ⊖ and ⊕ buttons. Exit the screen with the button ⊙.

BUS DEVICES

The list of devices with which the controller is connected to the BUS connection is displayed on the screen.

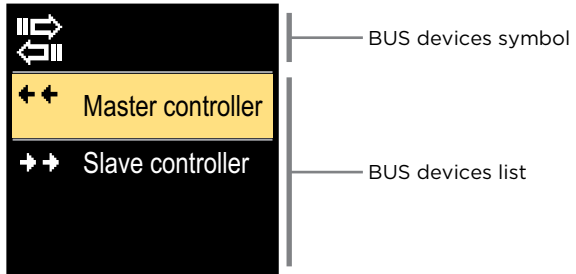

Navigate through the list with the \ominus and \oplus buttons. Exit the screen with the button \odot .

Symbol	Description
	Wired COM connection.
	Wired BUS connection between controllers.
	Room unit.
	GWD interface for WiFi cloud connection.
	Wireless outdoor temperature sensor.
$\leftarrow \leftarrow$	The master controller is connected to the BUS connection.
$\rightarrow \rightarrow$	The slave controller is connected to the BUS connection.

The menu contains tools for resetting the controller to saved or factory settings.

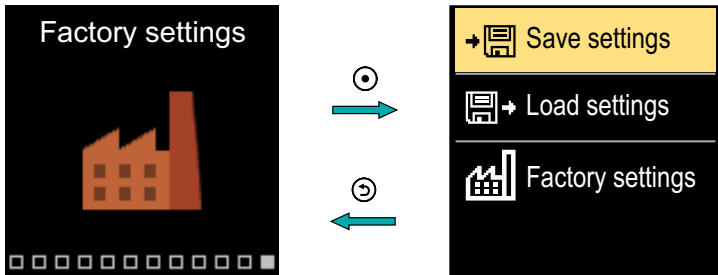

Navigate through the menu with the \ominus and \oplus buttons. When you use the \odot button to select the requested command, a display will open for unlocking or confirming the command. Exit the setting with the \odot button.

Symbol	Description
	Save user settings as a backup.
	Load user settings from backup. If a backup doesn't exist, this command is not executed.
	Restores all parameters to default values and restarts the controller initial setup.

MIXING HEATING CIRCUIT

Stand-pipe temperature calculation for heating

The calculation of the stand-pipe temperature for heating is limited by the maximum temperature of the stand-pipe – parameter S2.6 and by the minimum temperature of the stand-pipe – parameter S2.5. The influence of the room temperature deviation on the stand-pipe calculation can be set up with the parameter S2.1. The heating curve steepness can be set up with the parameter P2.1 and parallel shift of the heating curve with the parameter P2.2.

Stand-pipe temperature calculation for cooling

The stand-pipe temperature calculation for cooling is limited by the set minimum temperature of the stand-pipe for cooling – parameter S2.11. The influence of the room temperature deviation on the stand-pipe calculation can be set up with the parameter S2.16. The cooling curve steepness can be set up with the parameter P2.6 and parallel shift of the cooling curve with the parameter P2.7.

Heating operation

If the calculated temperature of the stand-pipe is not slightly higher than the room temperature, the mixing valve closes. If the room temperature is not measured, the mixing valve closes when the outdoor temperature approaches the requested room temperature. With the parameter S2.12, the required difference between the calculated temperature of the stand-pipe and room temperature, at which the mixing valve is deactivated, can be increased or reduced. If heating is not required or not activated, the value 4°C will show as the calculated stand-pipe temperature and the circulating pump will switch off with a delay – parameter S2.15. Other pump operation modes can be selected with parameter S2.4.

Cooling operation

If the calculated temperature of the stand-pipe is not slightly lower than the room temperature, the mixing valve closes. If the room temperature is not measured, the mixing valve closes when the outdoor temperature approaches the requested room temperature. With the parameter S2.12, the required difference between the calculated temperature of the stand-pipe and room temperature, at which the cooling is deactivated, can be increased or reduced. If cooling is not required or not included, the value 34°C will show as the calculated stand-pipe temperature and the circulating pump will switch off with a delay – parameter S2.15. Other pump operation modes can be selected with parameter S2.4.

Intensive - BOOST heating

Define time and intensity of intensive (BOOST) heating, which is activated at transition of time program from night to day heating interval with parameters P3.3 and P3.4. By setting the Boost function, the time required to achieve the requested room temperature after the transition from the night into day time interval can be reduced.

Heating circuit power limitation (ΔT limitation)

When you want to limit the maximum starting power of an individual heating circuit, you use an additional sensor T4 to measure the return-pipe temperature of the mixing heating circuit. The setup for the parameter S1.7=Return-pipe is required and with the parameter S2.13, the maximum permissible difference between the temperature of the stand-pipe and return-pipe can be set up. The controller now restricts the stand temperature by not exceeding the set-up difference between the stand and return temperature.

HEATING AND COOLING CURVE

The curve steepness indicates what temperature is required for the heating or cooling bodies by a determined outdoor temperature. The steepness value depends mainly on the system type (floor, wall, radiator, convector) and insulation of the building. If you have enough data, you can determine the heating curve steepness with a calculation, otherwise it's from experience, based on the evaluation of the heating system dimensioning and building insulation. The heating curve steepness is set correctly, if the room temperature remains stable, even if there are large outdoor temperature changes.

Determining the heating curve steepness

While the outdoor temperature is above + 5 °C, you can adjust the room temp. by changing the day or night temp, or with the parallel shift of the heating curve (parameter P2.2). If the object temp. is too low because of low outdoor temperatures, the heat curve steepness needs to be increased. If the object temp. is too high because of low outdoor temperatures, the heat curve steepness needs to be decreased. The maximum steepness increase/decrease should not be greater than 0.1 to 0.2 units per one observation. At least 24 hours must pass between two observations.

Preferred settings of the heating curve steepness:

System	Steepness setting range
Floor	0.2 - 0.8
Wall	0.5 - 1.0
Radiator	0.7 - 1.4



By adjusting the heating curve the controller is adapted to the regulated building. For optimal controller operation, the right setting of the heat curve steepness is very important.

Heat curve diagram:

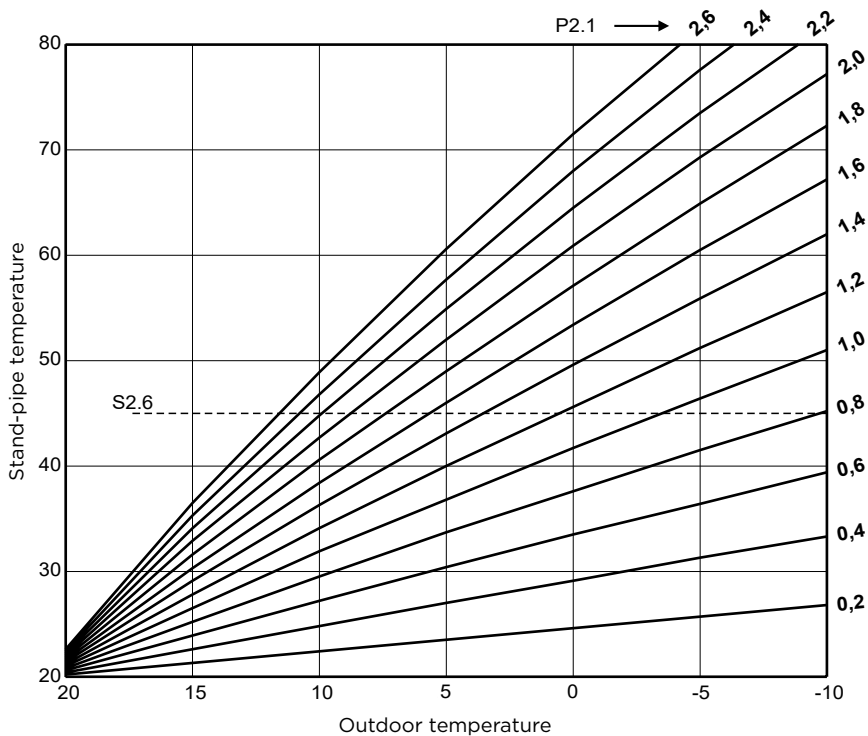

Cooling curve diagram:

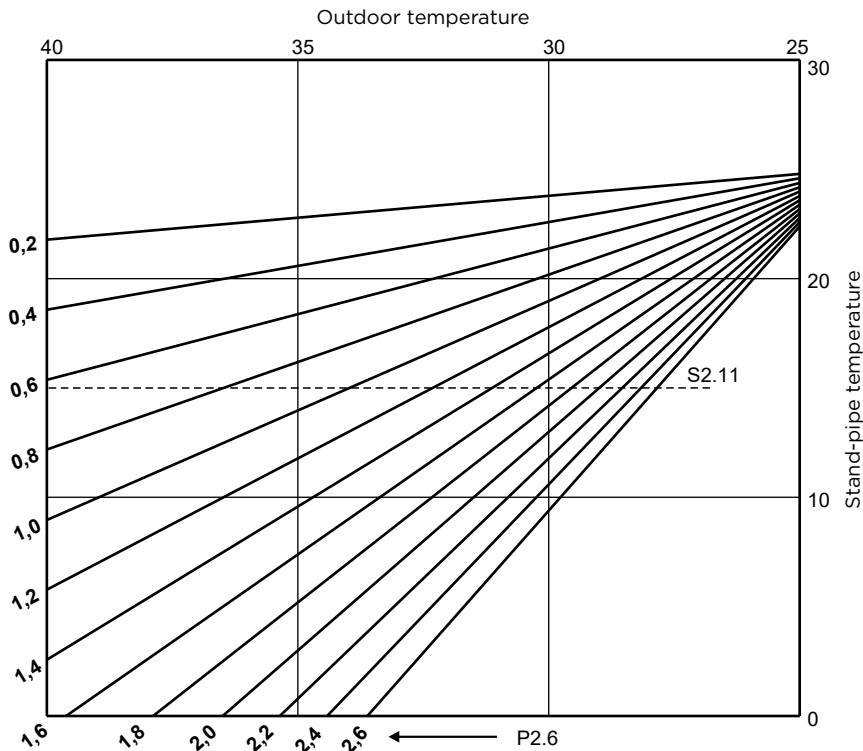

OPERATION MODES WITH SENSOR FAILURE

Outdoor sensor is not connected or has a failure.

- **Heating:** The controller acts as a P-controller with respect to the room temperature deviation.

- **Cooling:** The controller acts as a room thermostat by limiting the minimum supply temperature.

The outdoor and room sensor are not connected or are defective.

- **Heating:** The controller regulates the stand-pipe to a constant temperature, which is: 25 °C higher than the requested day or night temperature; for radiator heating systems, 10 °C higher than the requested day or night temperature; for floor heating systems.

- **Cooling:** In the daytime interval, the supply temperature is equal to the setting of parameter S2.11, and in the nighttime interval, cooling is switched off.

The room sensor is not connected or has a failure.

The controller operates according to the outdoor temperature, without the influence of the room sensor.

The stand-pipe sensor is not connected or has a failure.

- **Heating:** The controller assumes that the stand-pipe temperature is 120° C. The heating does not work and the mixing valve closes.

- **Cooling:** The controller assumes that the stand-pipe temperature is 4° C. Cooling does not work and the mixing valve closes.

The boiler sensor is not connected or has a failure.

The controller assumes that the boiler temperature is equal to the set maximum boiler temperature. The mixing valve control is working.

The return-pipe sensor is not connected or has a failure.

The controller operates without the influence of the return-pipe sensor.

TABLE: Resistance of Pt1000 temperature sensors

Temp. [°C]	Resistance [Ω]	Temp. [°C]	Resistance [Ω]	Temp. [°C]	Resistance [Ω]	Temp. [°C]	Resistance [Ω]
-20	922	35	1136	90	1347	145	1555
-15	941	40	1155	95	1366	150	1573
-10	961	45	1175	100	1385	155	1592
-5	980	50	1194	105	1404	160	1611
0	1000	55	1213	110	1423	165	1629
5	1020	60	1232	115	1442	170	1648
10	1039	65	1252	120	1461	175	1666
15	1058	70	1271	125	1480	180	1685
20	1078	75	1290	130	1498	185	1703
25	1097	80	1309	135	1515	190	1722
30	1117	85	1328	140	1536	195	1740

CLUTCH AND MANUAL VALVE DISPLACEMENT

EN

Pressing the clutch I. activates the manual valve displacement. You can now move the mixing valve by turning the button II. To return to automatic operation, press the clutch I. again. When the clutch is activated, the clutch symbol appears on the display.

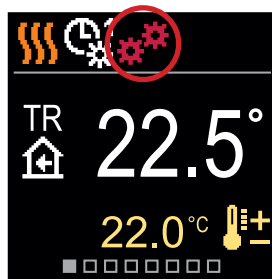
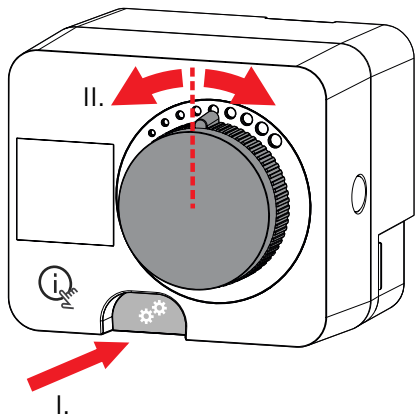

CONTROLLER INSTALLATION

EN

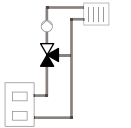
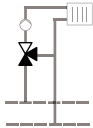
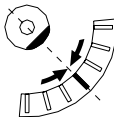
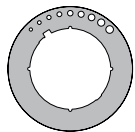
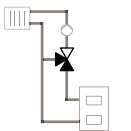
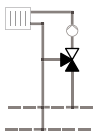
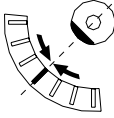
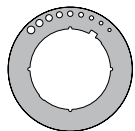
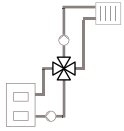
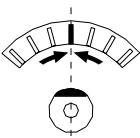
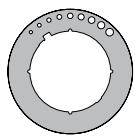
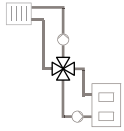
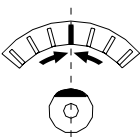
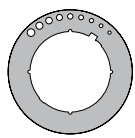
Scheme		Mixing valve position	Ring position
<p>360</p> 	<p>360b</p> 		
<p>360</p> 	<p>360b</p> 		
<p>361</p> 			
<p>361</p> 			

CONTROLLER ELECTRICAL CONNECTIONS

i

Any project with an AHD20 controller must be based on calculations and plans that are solely yours and in accordance with applicable regulations. Images and texts in these instructions serve as examples and the issuer does not assume any responsibility for them. The liability of the issuer for unprofessional, incorrect and false information that can result in damage is explicitly excluded. We reserve the right to technical errors or changes without giving prior notice.



The connection of controlling devices should be performed by an expert with an appropriate qualification, or by an authorised organisation. Before touching any wiring, make sure that the main switch is off. Low voltage installation regulations IEC 60364 and VDE 0100, statutory provisions for accident prevention, statutory provisions for environmental protection and other national rules must be observed.

CONNECTION OF TEMPERATURE SENSORS

Temperature sensors, wired room units and connections between controllers are connected to a pre-wired connecting rail.

The controller allows the connection of four Pt1000 temperature sensors (connection terminals 1 to 8). The sensor function depends on the hydraulic diagram and setup of parameters S1.6 and S1.7.

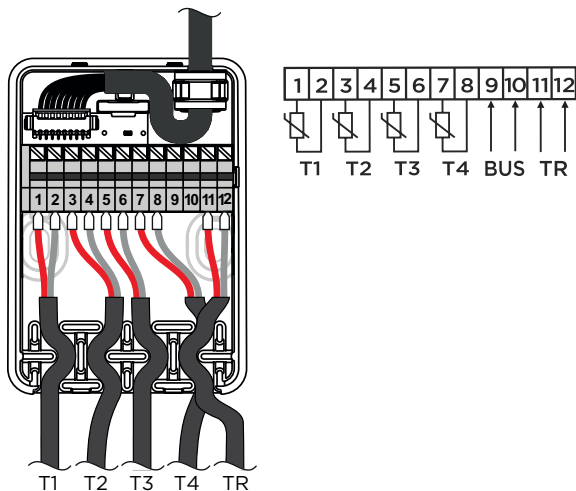

CONTROLLER ELECTRICAL CONNECTIONS

EN

CONNECTING THE WIRED ROOM UNIT

The controller allows the connection of a wired digital room unit. It measures the room temperature and enables the setting of requested day and night temperature, as well as selection of an operation mode. One room unit can be connected to one controller. Adding a wireless room unit is described in the "Devices" section.

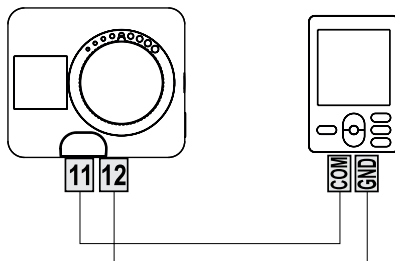

CONTROLLER ELECTRICAL CONNECTIONS

BUS CONNECTION OF CONTROLLERS

With the BUS connection, any number of AHD20 controllers can be connected to each other. The first or leading controller physically controls the energy sources, while the other controllers only control the heating circuits.



The outdoor temperature sensor and the sensor of the heat source temperature must be connected to the first controller.

Example of BUS connection of AHD20 controllers:

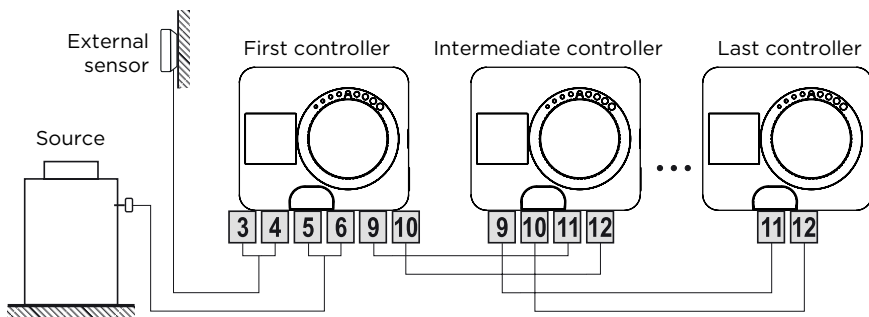

AUX FUNCTION AT INPUT T4

Input T4 can also be used for external actuation of the controller.

The external actuation options are set with parameter S1.9.

When a short circuit is detected at input T4, the following is activated:

- switch to daily temperature if parameter is set to S1.9 = Daily temperature.
- switch from heating to cooling if parameter is set to S1.9 = Cooling.
- switch to operation according to the selected time program if the parameter is set to S1.9 = Time program.
- Boost heating function if parameter is set to S1.9 = Boost.

When the AUX function is activated, the AUX symbol appears on the display.

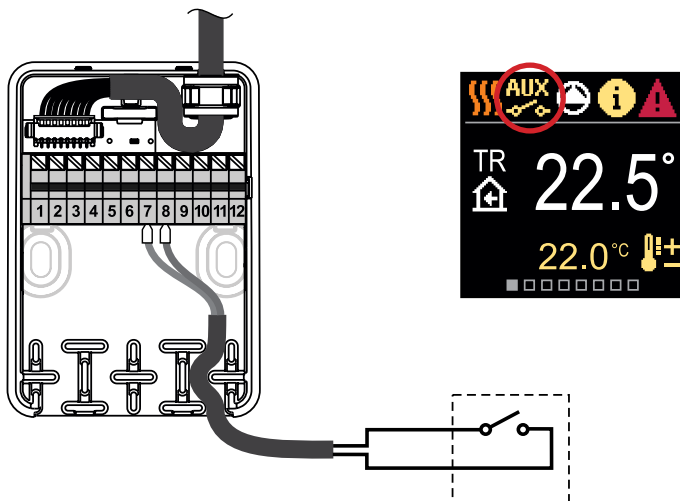

General technical data - controller

Dimensions	(w x h x l) 86.5 x 80.3 x 95 mm
Controller weight	~ 800 - 1000 g
Controller casing	PC - thermoplastic
Torque	5 Nm
Rotation angle	90 °
Rotation speed	2 min / 90 °
Type of operation	3-point, PID
Supply voltage	230 V -, 50 Hz
Energy consumption in operation	3,5 W
Energy consumption in standby	max. 0,5 W
Circulation pump control	2-point (ON/OFF), 1 (1) A 230 V-
Degree of protection	IP42 according to EN 60529
Safety class	I according to EN 60730-1
Accuracy of built-in clock	± 5 min/year
Permissible ambient temperature	5 °C to +40 °C
Permissible relative humidity	max. 85% rH at 25 °C
Storage temperature	-20 °C to +65 °C
Program class	A
Storing data without power	min. 10 years

Technical characteristics - sensors

Temperature sensor type	Pt1000
Sensor resistance	1078 Ohm at 20 °C
Temperature range	-25 ÷ 150 °C, IP32
Min. section of sensor conductors	0.3 mm ²
Max. length of sensor conductors	max. 10 m

REMOVING OLD ELECTRICAL AND ELECTRONIC EQUIPMENT



EN

Disposal of Old Electrical & Electronic Equipment (Applies to EU Member states and other European countries with a separate waste collection system).



This symbol on the product or packaging marks that it should not be discarded as household waste. It needs to be taken to a collection point for waste electrical and electronic equipment (WEEE). Suitable disposal of this product prevents negative effect on the environment and health which could otherwise be caused by its unsuitable disposal. Recycling of material reduces usage of new raw materials. For more information on recycling of this product, contact the competent authorities, municipal service or the store where you purchased the product.

ATTENTION! Installation schemes show the principle of operation and do not contain all the auxiliary and safety elements! The applicable regulations must be observed during installation!

-  Mandatory sensor
-  Optional sensor

Scheme 360 - heating circuit

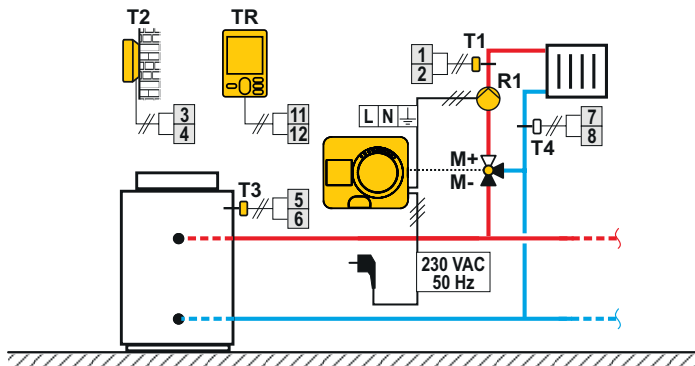

Scheme 360b - additional heating circuit

